



TERRAX

# PLANT TRAILERS FOR PROFESSIONALS



PLANT TRAILERS 

MULTIPURPOSE TRAILERS 

TIPPING TRAILERS 

FLATBED TRAILERS 



PLANT TRAILERS **TERRAX**



**“THE TERRAX IS MY BEST INVESTMENT”**

## Terrax: professional equipment

Professionals can rely on the quality of Hulco Terrax plant trailers and load them to the max – a challenge the Terrax is built for. The strong chassis with its many tubular profiles creates an excellent loading floor support. The low floor height, in conjunction with the robust tailgate ramp, shovel-support, multiple tie-down points and integrated lights, makes the Terrax a professional tool, ideal for excavators, platform machines and shovels.



Terrax tandem



Terrax tridem



Terrax Go-Getter tandem



Terrax Go-Getter tridem

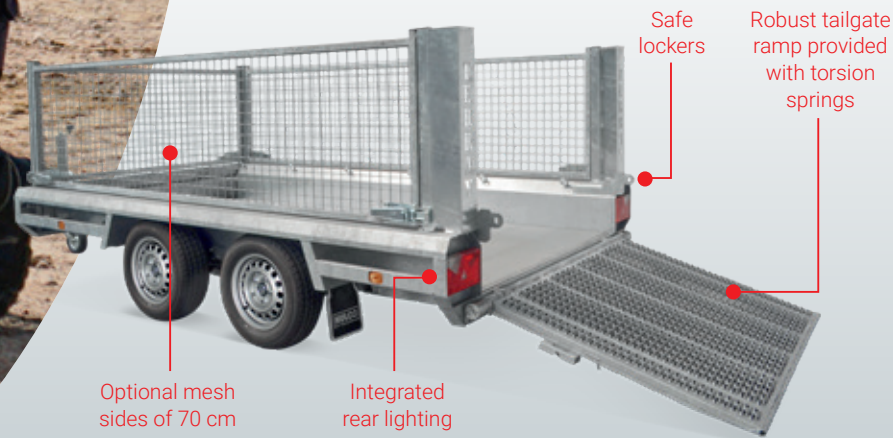

Optional mesh sides of 70 cm

Integrated rear lighting

Safe lockers

Robust tailgate ramp provided with torsion springs

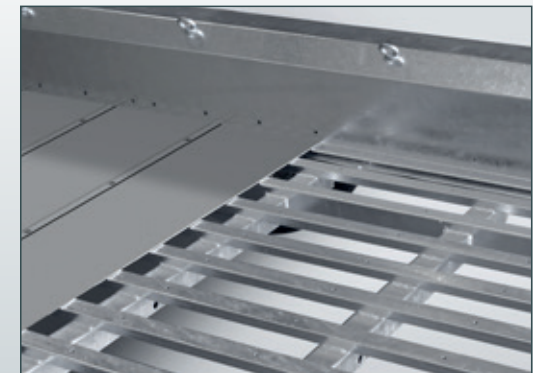

Many longitudinal beams creates extremely strong floor support



Extremely strong platform support because of the many bearers



Integrated rear lighting



Many fixed tie-down possibilities



Integrated propstands on tailgate ramp (no extra propstands needed)



Standard equipped with excavator bucket support on the A-frame



Very small slope angle



Accessory: winch with support

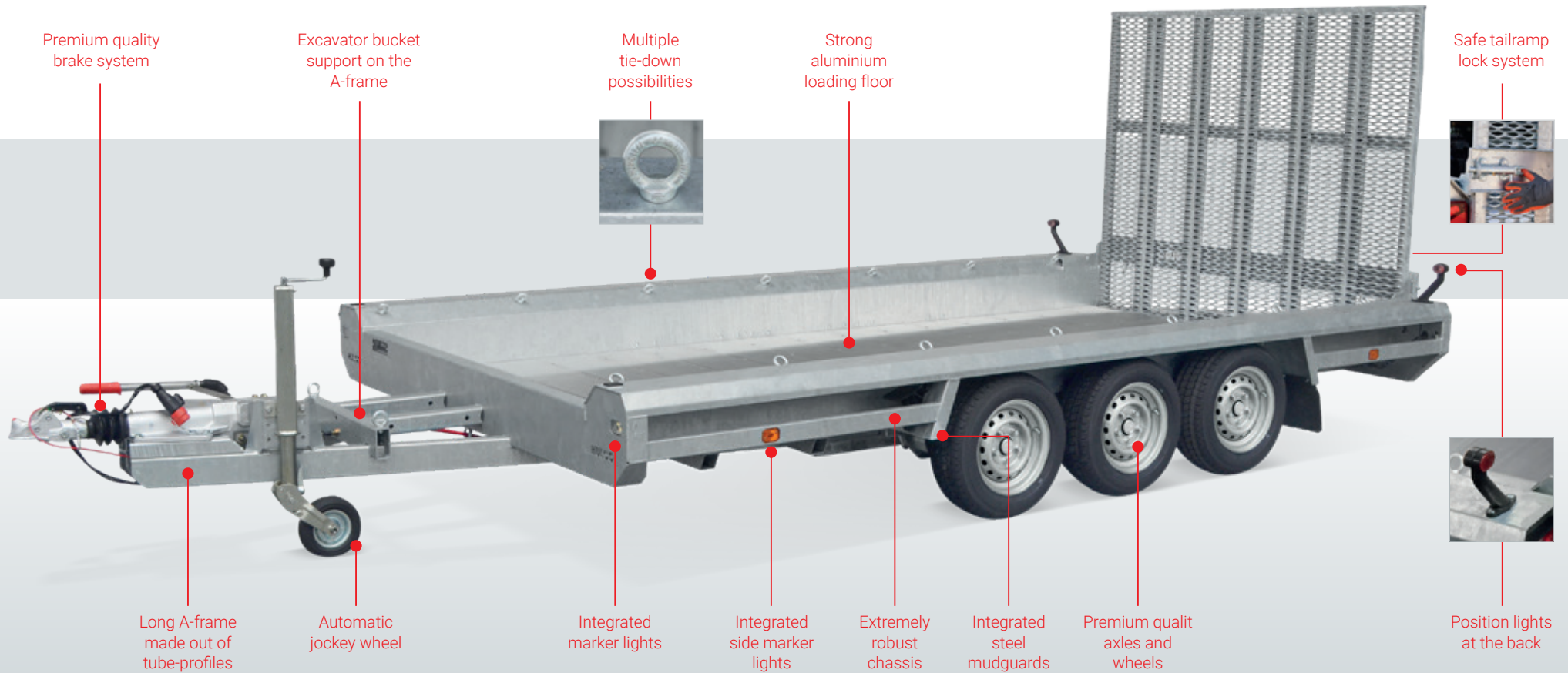

Premium quality brake system

Excavator bucket support on the A-frame

Multiple tie-down possibilities

Strong aluminium loading floor

Safe tailramp lock system

Long A-frame made out of tube-profiles

Automatic jockey wheel

Integrated marker lights

Integrated side marker lights

Extremely robust chassis

Integrated steel mudguards

Premium quality axles and wheels

Position lights at the back



**“THE TERRAX IS MY  
BEST INVESTMENT”**

## Terrax Go-Getter

The Terrax Go-Getter is made for those who want to stand out and benefit from its many extras, including anti-skid strips, an extra-heavy jockey wheel, black sideskirts, black steel rims and full LED lighting.





Heavy-duty jockey wheel



Fully equipped with LED lighting



Glued non-slip strips



Integrated propstands on tailgate ramp

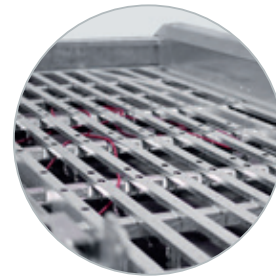

Extremely strong platform support because of the many bearers



Black sideskirts and rims



Torsion springs support tailgate ramp

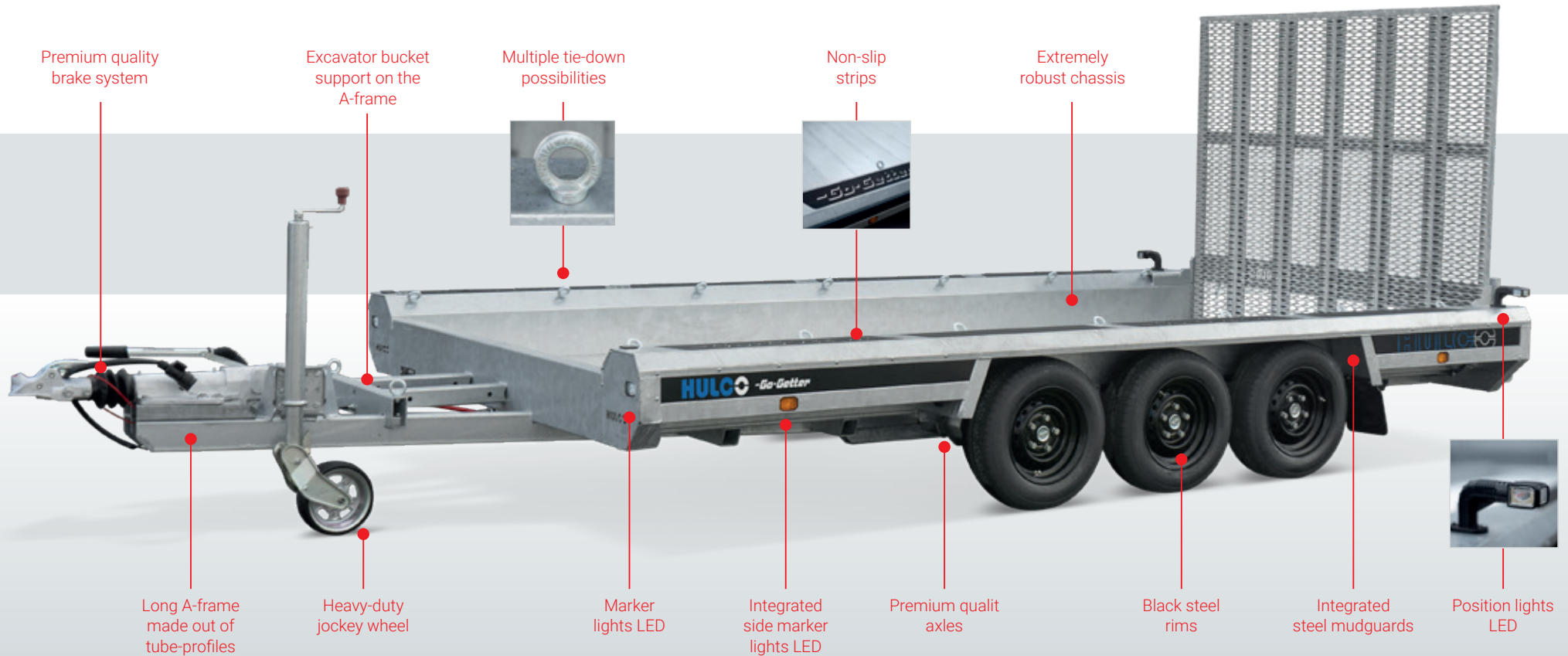

Premium quality brake system

Excavator bucket support on the A-frame

Multiple tie-down possibilities

Non-slip strips

Extremely robust chassis

Long A-frame made out of tube-profiles

Heavy-duty jockey wheel

Marker lights LED

Integrated side marker lights LED

Premium quality axles

Black steel rims

Integrated steel mudguards

Position lights LED



**“SAFE AND QUICK BOARDING”**

## Plant trailers Terrax-Basic

Hulco has established a professional range of plant trailers. The Terrax-Basic models have been specially designed for smaller vehicles and machines. The Terrax-Basic is equipped with a high-grip plywood loading floor, ideal for transporting ATVs, quads, garden machines, and lawn mowers.

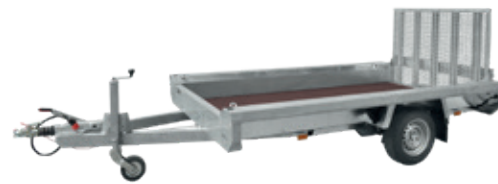

Terrax-Basic enkelas



Terrax-Basic tandem





Accessorie:  
Axle schock absorbers for  
extra driving comfort



Accessorie:  
Gas spring for tail ramp  
(ramp heigth 150 cm)



Accessorie:  
Mesh sides  
height 70 cm



Accessorie:  
Coupling raisers  
height 5 or 10 cm



Accessorie:  
Ladder rack  
height 80 cm



Accessorie:  
Terrax Wheelstop



Accessorie:  
Front filling piece  
(8 cm)

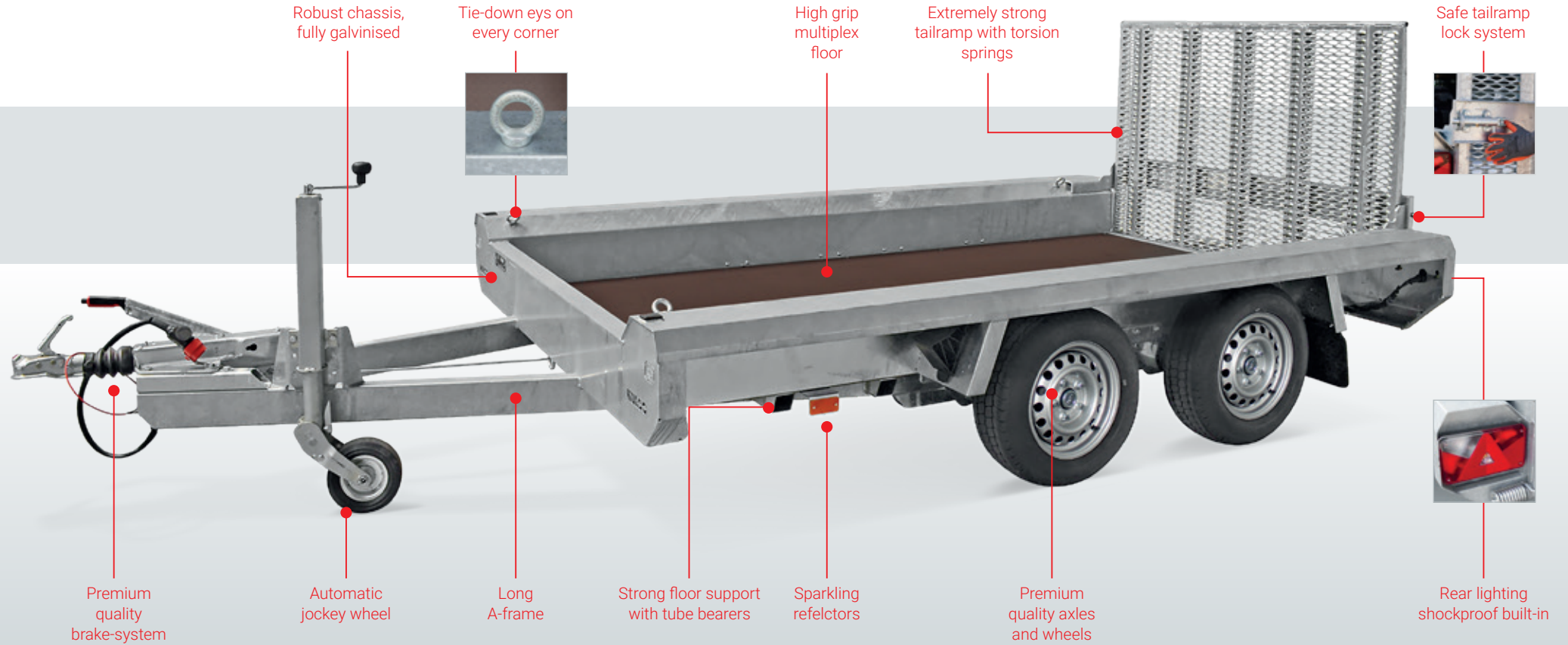

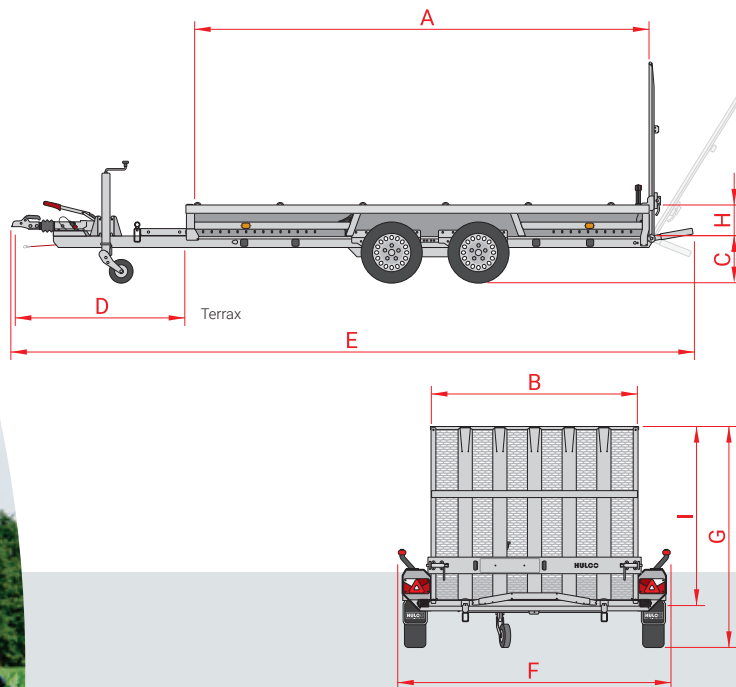

Type	Terrax-1 1500 294x150 Basic	Terrax-1 1800 294x150 Basic	Terrax-2 2600 294x150 Basic
<b>Gross capacity</b>	1500 kg	1800 kg	2600 kg
<b>Unladen weight (ULW)</b>	440 kg	460 kg	545 kg
<b>Load capacity</b>	1060 kg	1340 kg	2055 kg
<b>Axles pcs</b>	1	1	2
<b>Braked version</b>	✓	✓	✓
<b>Wheel / tyresize</b>	185/60R12	185/60R12	185/60R12
<b>Steel rims</b>	silver	silver	silver
<b>Floor type</b>	plywood	plywood	plywood
Internal length (A)	294 cm	294 cm	294 cm
Internal width (B)	150 cm	150 cm	150 cm
Floor height (C)	32 cm	39,5 cm	32 cm
A-Frame length (D)	145 cm	145 cm	145 cm
Total length (E)	473 cm	473 cm	473 cm
Total width (F)	200 cm	200 cm	200 cm
Total height (G)	135 cm	135 cm	135 cm
Side height (H)	27 cm	27 cm	27 cm
Tailgate ramp height (I)	100 cm	100 cm	100 cm



Accessoires	Terrax-1 1500 294x150 Basic	Terrax-1 1800 294x150 Basic	Terrax-2 2600 294x150 Basic
Mesh sides (H 70 cm)	✓	✓	✓
Spare wheel with support	✓	✓	✓
Ladder rack (H 80 cm)	✓	✓	✓
Front filling piece (H 8 cm)	✓	✓	✓
Coupling raisers (H 5 cm)	s	✓	s
Coupling raisers (H 10 cm)	✓	✓	✓
Axle shock absorbers	✓	✓	✓
Gas spring for tail ramp height 150 cm	✗	✗	✗
Winch and winchsupport	✗	✗	✗
Wheelstop	✓	✓	✓



Type	Terrax-2 3000 294x150	Terrax-2 3000 294x150 LK	Terrax-2 3500 294x150	Terrax-2 3000 344x165	Terrax-2 3000 344x165 LK	Terrax-2 3500 344x165	Terrax-2 3000 394x180	Terrax-2 3000 394x180 LK	Terrax-2 3500 394x180	Terrax-2 3500 394x180 Go-Getter	Terrax-3 3500 394x180	Terrax-3 3500 394x180 Go-Getter	Terrax-3 3500 394x180 LK	Terrax-2 3500 469x195 LK	Terrax-3 3500 469x195 LK
<b>Gross capacity</b>	3000 kg	3000 kg	3500 kg	3000 kg	3000 kg	3500 kg	3000 kg	3000 kg	3500 kg	3500 kg	3500 kg	3500 kg	3500 kg	3500 kg	3500 kg
<b>Unladen weight (ULW)</b>	650 kg	685 kg	730 kg	695 kg	730 kg	775 kg	785 kg	825 kg	875 kg	875 kg	905 kg	905 kg	945 kg	950 kg	1075 kg
<b>Load capacity</b>	2350 kg	2315 kg	2770 kg	2305 kg	2270 kg	2725 kg	2215 kg	2175 kg	2625 kg	2625 kg	2595 kg	2595 kg	2555 kg	2550 kg	2425 kg
<b>Axles pcs</b>	2	2	2	2	2	2	2	2	2	2	3	3	3	2	3
<b>Braked version</b>	v	v	v	v	v	v	v	v	v	v	v	v	v	v	v
<b>Wheel / tyresize</b>	185/60R12	185/60R12	185/60R12	185/60R12	185/60R12	185/60R12	185/60R12	185/60R12	185/60R12	185/60R12	185/60R12	185/60R12	185/60R12	185/60R12	185/60R12
<b>Steel rims</b>	silver	silver	silver	silver	silver	silver	silver	silver	silver	black	silver	black	silver	silver	silver
<b>Floor type</b>	aluminium	aluminium	aluminium	aluminium	aluminium	aluminium	aluminium	aluminium	aluminium	aluminium	aluminium	aluminium	aluminium	aluminium	aluminium
Internal length (A)	294 cm	294 cm	294 cm	344 cm	344 cm	344 cm	394 cm	394 cm	394 cm	394 cm	394 cm	394 cm	394 cm	469 cm	469 cm
Internal width (B)	150 cm	150 cm	150 cm	165 cm	165 cm	165 cm	180 cm	180 cm	180 cm	180 cm	180 cm	180 cm	180 cm	195 cm	195 cm
Floor height (C)	32 cm	32 cm	39,5 cm	32 cm	32 cm	39,5 cm	32 cm	32 cm	39,5 cm	39,5 cm	32 cm	32 cm	32 cm	39,5 cm	39,5 cm
A-Frame length (D)	145 cm	145 cm	145 cm	145 cm	145 cm	145 cm	145 cm	145 cm	145 cm	145 cm	145 cm	145 cm	145 cm	145 cm	145 cm
Total length (E)	473 cm	473 cm	485 cm	525 cm	525 cm	536 cm	573 cm	573 cm	585 cm	585 cm	575 cm	575 cm	575 cm	661 cm	661 cm
Total width (F)	200 cm	200 cm	200 cm	215 cm	215 cm	215 cm	230 cm	230 cm	230 cm	230 cm	230 cm	230 cm	230 cm	245 cm	245 cm
Total height (G)	135 cm	185 cm	193 cm	135 cm	185 cm	193 cm	135 cm	185 cm	193 cm	193 cm	135 cm	135 cm	185 cm	193 cm	193 cm
Side height (H)	27 cm	27 cm	27 cm	27 cm	27 cm	27 cm	27 cm	27 cm	27 cm	27 cm	27 cm	27 cm	27 cm	27 cm	27 cm
Tailgate ramp height (I)	100 cm	150 cm	150 cm	100 cm	150 cm	150 cm	100 cm	150 cm	150 cm	150 cm	100 cm	150 cm	150 cm	150 cm	150 cm

Accessoires	Terrax-2 3000 294x150	Terrax-2 3000 294x150 LK	Terrax-2 3500 294x150	Terrax-2 3000 344x165	Terrax-2 3000 344x165 LK	Terrax-2 3500 344x165	Terrax-2 3000 394x180	Terrax-2 3000 394x180 LK	Terrax-2 3500 394x180	Terrax-2 3500 394x180 Go-Getter	Terrax-3 3500 394x180	Terrax-3 3500 394x180 Go-Getter	Terrax-3 3500 394x180 LK	Terrax-2 3500 469x195 LK	Terrax-3 3500 469x195 LK
Mesh sides (H 70 cm)	v	v	v	v	v	v	v	v	v	v	v	v	v	x	x
Spare wheel with support	v	v	v	v	v	v	v	v	v	v	v	v	v	v	v
Ladder rack (H 80 cm)	v	v	v	v	v	v	v	v	v	v	v	v	v	v	v
Front filling piece (H 8 cm)	v	v	v	v	v	v	v	v	v	v	v	v	v	x	x
Coupling raisers (H 5 cm)	s	s	v	s	s	v	s	s	v	v	s	s	s	v	v
Coupling raisers (H 10 cm)	v	v	v	v	v	v	v	v	v	v	v	v	v	v	v
Axle shock absorbers	v	v	v	v	v	v	v	v	v	v	v	v	v	v	v
Gas spring for tail ramp height 150 cm	x	v	v	x	v	v	x	v	v	v	x	v	v	v	v
Winch and winchsupport	v	v	v	v	v	v	v	v	v	v	v	v	v	v	v
Wheelstop	v	v	v	v	v	v	v	v	v	v	v	v	v	v	v

s standard equipment v available as an accessor x no accessory

**“LET HULCO DO THE  
HEAVY LIFTING”**





## More Hulco

Besides the Terrax plant trailers, Hulco also makes the Medax flatbed trailers with spaceframe and the Carax multipurpose trailers for large vehicles. Check [www.hulco.eu](http://www.hulco.eu) for the complete range.



# Hulco, for professionals with standards.

You've got everything you need right behind you, because Hulco has been here for you since 2003. Hulco trailers are for the real professional; they are trailers for the toughest jobs, with uncompromising quality, indestructible construction, and premium quality materials and perfect finish. We don't shy away from complexity, and we exceed the wishes of professionals due to our well-thought-out design and automated processes. This allows us to consistently deliver the highest quality, carefully assembled and quality-controlled products, including accessories from our own factory. And everything we do, we do for the Hulco user; that is why our offer is so competitive.

Visit: [www.hulco.eu](http://www.hulco.eu)



Your Hulco dealer

HB2501EN-TER



Modell- and construction changes are without prejudice, even as printing and typing errors.



## The Anssems Group:

### Hulco Trailers GmbH

Wiener Straße 34  
D-48455 Bad Bentheim-Gildehaus  
[www.hulco.eu](http://www.hulco.eu)

### Anssems Aanhangwagens B.V.

Ericssonstraat 50  
NL-5121 ML Rijen  
[www.anssems.eu](http://www.anssems.eu)

### Anssems Anhänger GmbH

Londoner Straße 15  
D-48455 Bad Bentheim-Gildehaus  
[www.anssems.com](http://www.anssems.com)

### Anssems Remorques Sarl

Rue Pierre Brossolette  
FR-58600 Garchizy